

GT5050

GT5055

GT5560

GT6060

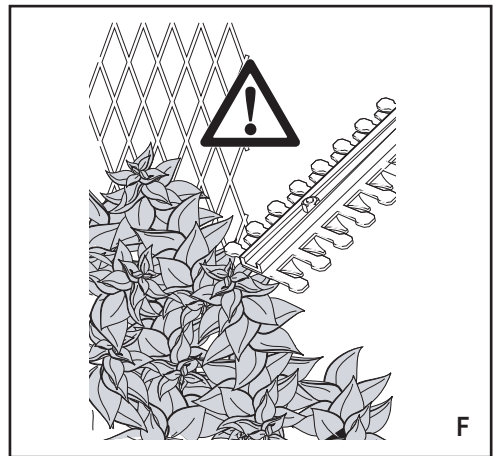
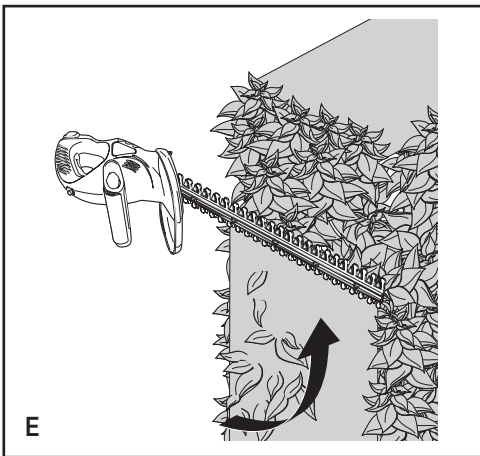
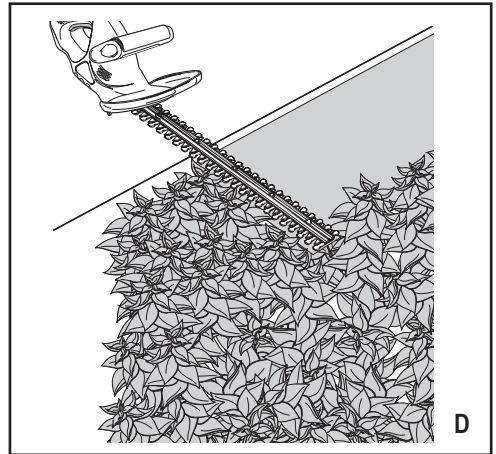
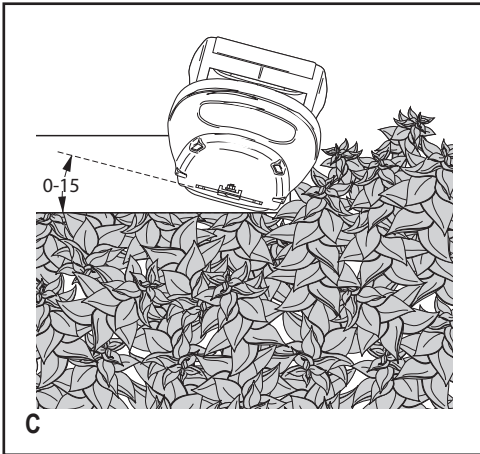
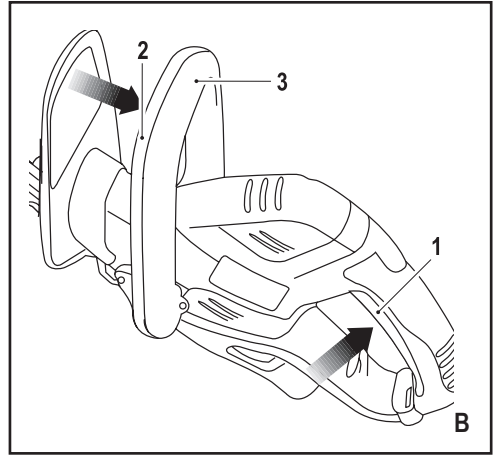
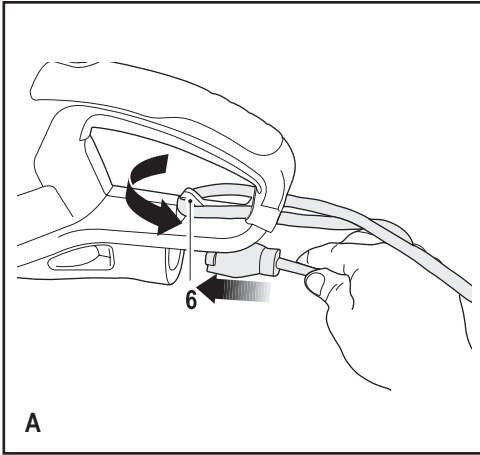

Intended use

Your Black & Decker hedgetrimmer has been designed for trimming hedges, shrubs and brambles. This tool is intended for consumer use only.

Safety instructions

General power tool safety warnings



Warning! Read all safety warnings and all instructions. Failure to follow the warnings and instructions listed below may result in electric shock, fire and/or serious injury.

Save all warnings and instructions for future reference.

The term "power tool" in the warnings refers to your mains operated (corded) power tool or battery operated (cordless) power tool.

1. Work area safety

- a. **Keep work area clean and well lit.** Cluttered or dark areas invite accidents.
- b. **Do not operate power tools in explosive atmospheres, such as in the presence of flammable liquids, gases or dust.** Power tools create sparks which may ignite the dust or fumes.
- c. **Keep children and bystanders away while operating a power tool.** Distractions can cause you to lose control.

2. Electrical safety

- a. **Power tool plugs must match the outlet. Never modify the plug in any way. Do not use any adapter plugs with earthed (grounded) power tools.** Unmodified plugs and matching outlets will reduce risk of electric shock.
- b. **Avoid body contact with earthed or grounded surfaces such as pipes, radiators, ranges and refrigerators.** There is an increased risk of electric shock if your body is earthed or grounded.
- c. **Do not expose power tools to rain or wet conditions.** Water entering a power tool will increase the risk of electric shock.
- d. **Do not abuse the cord. Never use the cord for carrying, pulling or unplugging the power tool. Keep cord away from heat, oil, sharp edges or moving parts.** Damaged or entangled cords increase the risk of electric shock.
- e. **When operating a power tool outdoors, use an extension cord suitable for outdoor use.** Use of a cord suitable for outdoor use reduces the risk of electric shock.
- f. **If operating a power tool in a damp location is unavoidable, use a residual current device (RCD) protected supply.** Use of an RCD reduces the risk of electric shock.

3. Personal safety

- a. **Stay alert, watch what you are doing and use common sense when operating a power tool. Do not use a power tool while you are tired or under the influence of drugs, alcohol or medication.** A moment of inattention while operating power tools may result in serious personal injury.
- b. **Use personal protective equipment. Always wear eye protection.** Protective equipment such as dust mask, non-skid safety shoes, hard hat, or hearing protection used for appropriate conditions will reduce personal injuries.
- c. **Prevent unintentional starting. Ensure the switch is in the off-position before connecting to power source and/or battery pack, picking up or carrying the tool.** Carrying power tools with your finger on the switch or energising power tools that have the switch on invites accidents.
- d. **Remove any adjusting key or wrench before turning the power tool on.** A wrench or a key left attached to a rotating part of the power tool may result in personal injury.
- e. **Do not overreach. Keep proper footing and balance at all times.** This enables better control of the power tool in unexpected situations.
- f. **Dress properly. Do not wear loose clothing or jewellery. Keep your hair, clothing and gloves away from moving parts.** Loose clothes, jewellery or long hair can be caught in moving parts.
- g. **If devices are provided for the connection of dust extraction and collection facilities, ensure these are connected and properly used.** Use of dust collection can reduce dust-related hazards.

4. Power tool use and care

- a. **Do not force the power tool. Use the correct power tool for your application.** The correct power tool will do the job better and safer at the rate for which it was designed.
- b. **Do not use the power tool if the switch does not turn it on and off.** Any power tool that cannot be controlled with the switch is dangerous and must be repaired.
- c. **Disconnect the plug from the power source and/or the battery pack from the power tool before making any adjustments, changing accessories, or storing power tools.** Such preventive safety measures reduce the risk of starting the power tool accidentally.
- d. **Store idle power tools out of the reach of children and do not allow persons unfamiliar with the power tool or these instructions to operate the power tool.** Power tools are dangerous in the hands of untrained users.

- e. **Maintain power tools. Check for misalignment or binding of moving parts, breakage of parts and any other condition that may affect the power tools operation. If damaged, have the power tool repaired before use.** Many accidents are caused by poorly maintained power tools.
 - f. **Keep cutting tools sharp and clean.** Properly maintained cutting tools with sharp cutting edges are less likely to bind and are easier to control.
 - g. **Use the power tool, accessories and tool bits etc. in accordance with these instructions, taking into account the working conditions and the work to be performed.** Use of the power tool for operations different from those intended could result in a hazardous situation.
5. **Service**
- a. **Have your power tool serviced by a qualified repair person using only identical replacement parts.** This will ensure that the safety of the power tool is maintained.

Additional power tool safety warnings



Warning! Additional safety warnings for hedge trimmers

- ◆ **Keep all parts of the body away from the cutter blade. Do not remove cut material or hold material to be cut when blades are moving. Make sure the switch is off when clearing jammed material.** A moment of inattention while operating the tool can result in serious personal injury.
- ◆ **Carry the hedge trimmer by the handle with the cutter blade stopped. When transporting or storing the hedge trimmer always fit the cutting device cover.** Proper handling of the hedge trimmer will reduce possible personal injury from the cutter blades.
- ◆ **Hold the power tool by insulated gripping surfaces only, because the cutter blade may contact hidden wiring or its own cord.** Cutter blades contacting a "live" wire may make exposed metal parts of the power tool "live" and could give the operator an electric shock.
- ◆ **Keep cable away from cutting area.** During operation the cable can be hidden in shrubs and can be accidentally cut the blades.
- ◆ The intended use is described in this instruction manual. The use of any accessory or attachment or performance of any operation with this tool other than those recommended in this instruction manual can present a risk of personal injury and/or damage to property.
- ◆ If you have not used a hedge trimmer before, preferably seek practical instruction by an experienced user in addition to studying this manual.

- ◆ Never touch the blades while the tool is running.
- ◆ Never attempt to force the blades to come to a standstill.
- ◆ Do not put the tool down until the blades have come to a complete standstill.
- ◆ Regularly check the blades for damage and wear. Do not use the tool when the blades are damaged.
- ◆ Take care to avoid hard objects (e.g. metal wire, railings) when trimming. Should you accidentally hit any such object, immediately switch the tool off and check for any damage.
- ◆ Should the tool start to vibrate abnormally, immediately switch it off and disconnect it from the mains supply then check for any damage.
- ◆ If the tool stalls, immediately switch it off. Disconnect it from the mains supply before attempting to remove any obstructions.
- ◆ After use, place the blade sheath supplied over the blades. Store the tool, making sure that the blade is not exposed.
- ◆ Always ensure that all guards are fitted when using the tool. Never attempt to use an incomplete tool or a tool with unauthorised modifications.
- ◆ Never allow children to use the tool.
- ◆ Be aware of falling debris when cutting the higher sides of a hedge.
- ◆ Always hold the tool with both hands and by the handles provided.

Safety of others

- ◆ This appliance is not intended for use by persons (including children) with reduced physical, sensory or mental capabilities, or lack of experience and knowledge, unless they have been given supervision or instruction concerning use of the appliance by a person responsible for their safety.
- ◆ Children should be supervised to ensure that they do not play with the appliance.

Residual risks.

Additional residual risks may arise when using the tool which may not be included in the enclosed safety warnings. These risks can arise from misuse, prolonged use etc.

Even with the application of the relevant safety regulations and the implementation of safety devices, certain residual risks can not be avoided. These include:

- ◆ Injuries caused by touching any rotating/moving parts.
- ◆ Injuries caused when changing any parts, blades or accessories.
- ◆ Injuries caused by prolonged use of a tool. When using any tool for prolonged periods ensure you take regular breaks.
- ◆ Impairment of hearing.

- ◆ Health hazards caused by breathing dust developed when using your tool (example:- working with wood, especially oak, beech and MDF.)

Vibration

The declared vibration emission values stated in the technical data and the declaration of conformity have been measured in accordance with a standard test method provided by EN 60745 and may be used for comparing one tool with another. The declared vibration emission value may also be used in a preliminary assessment of exposure.

Warning! The vibration emission value during actual use of the power tool can differ from the declared value depending on the ways in which the tool is used. The vibration level may increase above the level stated.

When assessing vibration exposure to determine safety measures required by 2002/44/EC to protect persons regularly using power tools in employment, an estimation of vibration exposure should consider, the actual conditions of use and the way the tool is used, including taking account of all parts of the operating cycle such as the times when the tool is switched off and when it is running idle in addition to the trigger time.

Labels on tool

The following pictograms are shown on the tool:



Warning! To reduce the risk of injury, the user must read the instruction manual.



Wear safety glasses or goggles when operating this tool.



Wear ear protection when operating this tool.



Immediately disconnect the cable from the mains if it is damaged or cut.



Do not expose the tool to rain or high humidity.



Directive 2000/14/EC guaranteed sound power.

Electrical safety



This tool is double insulated; therefore no earth wire is required. Always check that the power supply corresponds to the voltage on the rating plate.

- ◆ If the supply cord is damaged, it must be replaced by the manufacturer or an authorised Black & Decker Service Centre in order to avoid a hazard.
- ◆ When using the tool outdoors, only use extension cables intended for outdoor use. A suitable rated Black & Decker extension cable of up to 30 m can be used without loss of power.
- ◆ Electric safety can be further improved by using a high-sensitivity 30 mA residual current device (RCD).

Features

This tool includes some or all of the following features.

1. Trigger switch
2. Front handle bail arm
3. Front handle
4. Guard
5. Blade
6. Cable restraint

Assembly

Warning! Before assembly, make sure that the tool is switched off and unplugged and that the blade sheath is fitted over the blades.

Warning! Never use the tool without the guard.

Connecting the tool to the mains (fig. A)

Unless the tool is fitted with a mains cable, you will need to connect an extension cable to the power inlet.

- ◆ Connect the female socket of a suitable extension cable to the power inlet of the tool.
- ◆ Loop the cable through the cable restraint (6) as shown to prevent the extension cable from becoming detached during use.
- ◆ Insert the mains plug into a mains outlet.

Warning! The extension cable must be suitable for outdoor use. When using a cable reel, always unwind the cable completely.

Use

Warning! Let the tool work at its own pace. Do not overload.

Switching on and off

Note: For your safety, this tool is equipped with a double switching system. This system prevents starting the tool inadvertently and will only allow operation while holding the tool with both hands.

Switching on (fig. B)

- ◆ Take hold of the front handle (3) with one hand so that the front handle bail arm (2) is pushed into the body of the front handle.
- ◆ With the other hand, squeeze the trigger switch (1) to start the tool.

Switching off

- ◆ Release the handle bail arm (2) or the trigger switch (1).

Warning! Never attempt to lock a switch in the on position.

Hints for optimum use

- ◆ Start by trimming the top of the hedge. Slightly tilt the tool (up to 15° relative to the line of cut) so that the blade tips point slightly towards the hedge (fig. C). This will cause the blades to cut more effectively. Hold the tool at the desired angle and move it steadily along the line of cut. The double-sided blade allows you to cut in either direction.
- ◆ In order to obtain a very straight cut, stretch a piece of string along the length of the hedge at the desired height. Use the string as a guideline, cutting just above it. (fig. D)
- ◆ In order to obtain flat sides, cut upwards with the growth. Younger stems move outwards when the blade cuts downwards, causing shallow patches in the hedge (fig. E).
- ◆ Take care to avoid any foreign objects. Especially avoid hard objects such as metal wire and railings, as these could damage the blades (fig. F).
- ◆ Regularly oil the blades.

Guidelines for trimming

- ◆ Trim hedges and shrubs with seasonal leaves (new leaves every year) in June and October.
- ◆ Trim evergreens in April and August.
- ◆ Trim conifers and other fast growing shrubs every six weeks from May until October.

Guidelines for trimming (Australia & New Zealand)

- ◆ Trim hedges and shrubs with seasonal leaves (new leaves every year) in December and March.
- ◆ Trim evergreens in September and February.
- ◆ Trim conifers and other fast growing shrubs every six weeks from October until March.

Accessories

The performance of your tool depends on the accessory used. Black & Decker and Piranha accessories are engineered to high quality standards and designed to enhance the performance of your tool. By using these accessories you will get the very best from your tool.

Maintenance

Your Black & Decker corded/cordless appliance/tool has been designed to operate over a long period of time with a minimum of maintenance. Continuous satisfactory operation depends upon proper tool care and regular cleaning.

Lubrication oil is available from your Black & Decker dealer (cat. no. A6102-XJ).

Warning! Before performing any maintenance on corded/cordless power tools:

- ◆ Switch off and unplug the appliance/tool.
- ◆ Or switch off and remove the battery from the appliance/tool if the appliance/tool has a separate battery pack.
- ◆ Or run the battery down completely if it is integral and then switch off.
- ◆ Unplug the charger before cleaning it. Your charger does not require any maintenance apart from regular cleaning.
- ◆ Regularly clean the ventilation slots in your appliance/tool/charger using a soft brush or dry cloth.
- ◆ Regularly clean the motor housing using a damp cloth. Do not use any abrasive or solvent-based cleaner.
- ◆ After use, carefully clean the blades. After cleaning, apply a film of light machine oil to prevent the blades from rusting.

Mains plug replacement (U.K. & Ireland only)

If a new mains plug needs to be fitted:

- ◆ Safely dispose of the old plug.
- ◆ Connect the brown lead to the live terminal in the new plug.
- ◆ Connect the blue lead to the neutral terminal.

Warning! No connection is to be made to the earth terminal. Follow the fitting instructions supplied with good quality plugs. Recommended fuse: 5 A.

Protecting the environment



Separate collection. This product must not be disposed of with normal household waste.

Should you find one day that your Black & Decker product needs replacement, or if it is of no further use to you, do not dispose of it with household waste. Make this product available for separate collection.



Separate collection of used products and packaging allows materials to be recycled and used again. Re-use of recycled materials helps prevent environmental pollution and reduces the demand for raw materials.

Local regulations may provide for separate collection of electrical products from the household, at municipal waste sites or by the retailer when you purchase a new product.

Black & Decker provides a facility for the collection and recycling of Black & Decker products once they have reached the end of their working life. To take advantage of this service please return your product to any authorised repair agent who will collect them on our behalf.

You can check the location of your nearest authorised repair agent by contacting your local Black & Decker office at the address indicated in this manual. Alternatively, a list of authorised Black & Decker repair agents and full details of our after-sales service and contacts are available on the Internet at: www.2helpU.com

Technical data

		GT5050 (Type 1)	GT5055 (Type 1)
Voltage	V_{AC}	230	230
Power input	W	500	500
Blade strokes (no load)	min^{-1}	1850	1835
Blade length	cm	50	55
Blade gap	mm	22	22
Blade brake time	s	<1	<1
Weight	kg	2.7	2.8

		GT5560 (Type 1)	GT6060 (Type 1)
Voltage	V_{AC}	230	230
Power input	W	550	600
Blade strokes (no load)	min^{-1}	1870	1840
Blade length	cm	60	60
Blade gap	mm	25	25
Blade brake time	s	<1	<1
Weight	kg	2.9	3.0

Level of sound pressure according to EN 60745:

Sound pressure (L_{pA}) 74 dB(A), uncertainty (K) 3 dB(A)

Sound power (L_{WA}) 94 dB(A), uncertainty (K) 3 dB(A)

Vibration total values (triax vector sum) according to EN 60745:

Vibration emission value ($a_{h,v}$) 2.9 m/s^2 , uncertainty (K) 1.5 m/s^2

EC declaration of conformityMACHINERY DIRECTIVE
OUTDOOR NOISE DIRECTIVE

GT5050 / GT5055 / GT5560 / GT6060

Black & Decker declares that these products described under "technical data" are in compliance with:

2006/42/EC, EN 60745-1, EN 60745-2-15

2000/14/EC, Hedge trimmer 1870 min-1, Annex V

Measured sound power (L_{pA}) 94 dB(A)

Uncertainty (K) 3 dB(A)

Guaranteed sound power (L_{pA}) 97 dB(A)

Uncertainty (K) 3 dB(A)

These products also comply with directive 2004/108/EC.
For more information, please contact Black & Decker at the following address or refer to the back of the manual.

The undersigned is responsible for compilation of the technical file and makes this declaration on behalf of Black & Decker.

Kevin Hewitt

Vice-President Global Engineering
Black & Decker Europe, 210 Bath Road, Slough,
Berkshire, SL1 3YD
United Kingdom
22/08/2011

Guarantee

Black & Decker is confident of the quality of its products and offers an outstanding guarantee. This guarantee statement is in addition to and in no way prejudices your statutory rights. The guarantee is valid within the territories of the Member States of the European Union and the European Free Trade Area.

If a Black & Decker product becomes defective due to faulty materials, workmanship or lack of conformity, within 24 months from the date of purchase, Black & Decker guarantees to replace defective parts, repair products subjected to fair wear and tear or replace such products to ensure minimum inconvenience to the customer unless:

- ◆ The product has been used for trade, professional or hire purposes;
- ◆ The product has been subjected to misuse or neglect;
- ◆ The product has sustained damage through foreign objects, substances or accidents;
- ◆ Repairs have been attempted by persons other than authorised repair agents or Black & Decker service staff.

To claim on the guarantee, you will need to submit proof of purchase to the seller or an authorised repair agent. You can check the location of your nearest authorised repair agent by contacting your local Black & Decker office at the address indicated in this manual. Alternatively, a list of authorised Black & Decker repair agents and full details of our after-sales service and contacts are available on the Internet at: www.2helpU.com

Please visit our website www.blackanddecker.co.uk to register your new Black & Decker product and to be kept up to date on new products and special offers. Further information on the Black & Decker brand and our range of products is available at www.blackanddecker.co.uk

Partial support - Only parts shown available
Nur die aufgeführten teile sind lieferbar
Reparation partielle - Seules les pièces indiquées sont disponibles
Supporto parziale - Sono disponibili soltanto le parti evidenziate
Solo estan disponibles las peizas listadas
So se encontram disponibles as pecas listadas
Gedeeltelijke ondersteuning - alleen de getoonde onderdelen
zijn beschikbaar

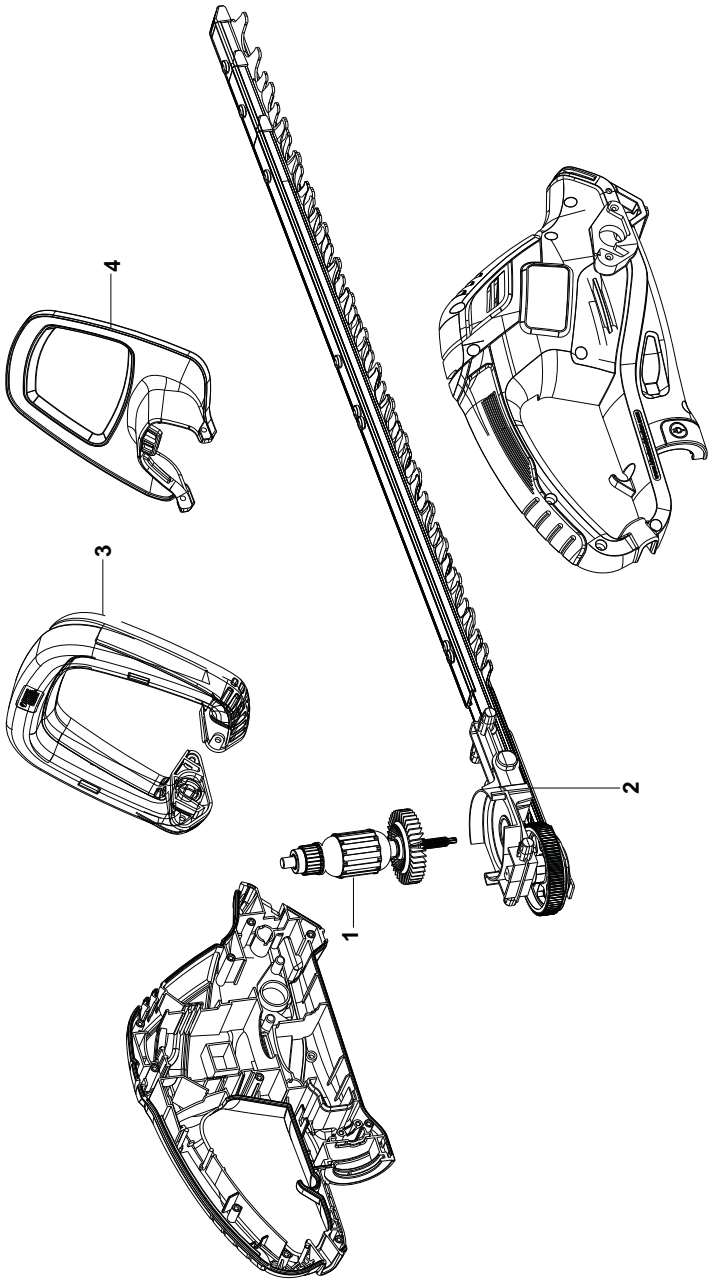

ENGLISH

Do not forget to register your product!

www.blackanddecker.co.uk/productregistration

Register your product online at **www.blackanddecker.co.uk/productregistration** or send your name, surname and product code to Black & Decker in your country.

Australia

Black & Decker (Australia) Pty. Ltd.
20 Fletcher Road, Mooroolbark,
Victoria, 3138

Tel. 03-8720 5100
Fax 03-9727 5940

New Zealand

Black & Decker
5 Te Apunga Place
Mt Wellington
Auckland 1060

Tel. +64 9 259 1133
Fax +64 9 259 1122

United Kingdom

Black & Decker
210 Bath Road
Slough, Berkshire SL1 3YD

Tel. 01753 511234
Fax 01753 551155